

Guardian Safe range is designed for the financial and commercial sectors' requirement for high risk protection against the wide range of sophisticated tools and techniques of attack used by the modern day criminal. Suitable for banks, trading houses, jewellery outlet and other institutions that hold large amounts of cash and valuables, the Guardian Safe provides a high degree of protection against a combination of various methods of burglary attacks.

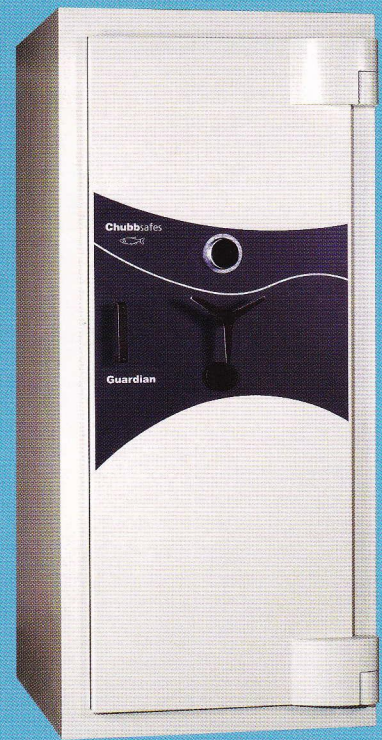

# Guardian Safe

burglar resistant safe

## Features

- Body** - The body consists of inner and outer plates enclosing a seamless casting of Chubb safes **CENTRIX III** specially formulated barrier material, solidly forming a monolithic structure that is consistent in strength. Its overall thickness of 100mm provides a formidable barrier to potential attacks in addition to its fire resisting properties.
- Door** - The door has an overall thickness of 212mm with an effective thickness of 100mm filled with Chubb safes **CENTRIX III** specially formulated steel fibre barrier material to increase the overall strength. For additional fire protection, a steel pan filled with fire resistant material is secured to the back of the door. The door is secured by 3-way moving steel bolts measuring 32mm in diameter. A full length docking bolt secures the back edge of the door.
- Locking** - Fitted with a 3-wheel Keyless Combination Lock and a 11-lever Key Lock.
- Both locks operate independently of each other. Both locks are protected by a Glass Relocker. The Relocker is further protected by a plate embedded with Tungsten Carbide pins. This further strengthens the drill resisting qualities of the Relocker. An additional 'Live' relocker is fitted for further protection.**
- Fire Resistance** - Tested in accordance to Section 8.5 of the Japanese Industrial Standard JIS S1037 - 1987 for a 90 minutes fire rating.
- Fitting** - The safe comes with a standard internal steel shelf, adjustable at intervals to suit individual customer requirements. Internal drawers are also made of steel and are individually secured by a key lock with keys in duplicate.
- Finish** - An Polyurethane base paint finish is used to coat the body and door. The paint is both scratch resistant and durable.



**Chubb safes**  
Trusted the world over.

BURGLAR  
RESISTANT

## Product Specifications

Size	External (mm)					Internal (mm)							Approx Nett weight(kgs)	Approx Gross weight(kgs)	Capacity (Litres)	No. of Front Bolts	No. of Shelf
	(A) Height	(B) Width	(C) Depth	(D) Clear depth over furniture	(E) Furniture Projection	(F) Height	(G) Width	(H) Depth	(I) Door swing	(J) Depth with door at 90°	(K) Width when door is fully open	(L) Drawer height					
1	1100	743	830	915	85	900	543	546	658	1530	1379	131	935	1010	267	4	1
2	1286	743	830	915	85	1086	543	546	658	1530	1379	131	1100	1181	322	4	1
3	1472	743	830	915	85	1272	543	546	658	1530	1379	131	1267	1352	377	5	2
4	1657	743	830	915	85	1457	543	546	658	1530	1379	131	1430	1520	432	6	2

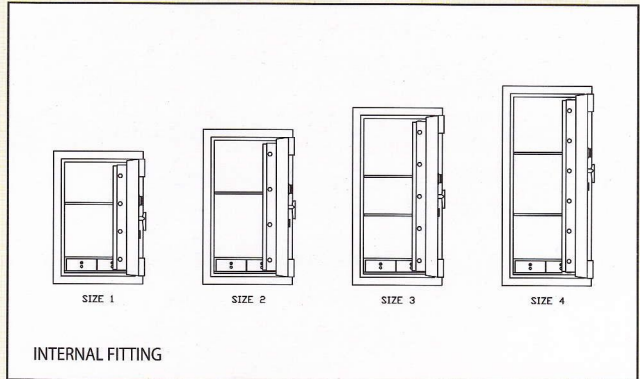
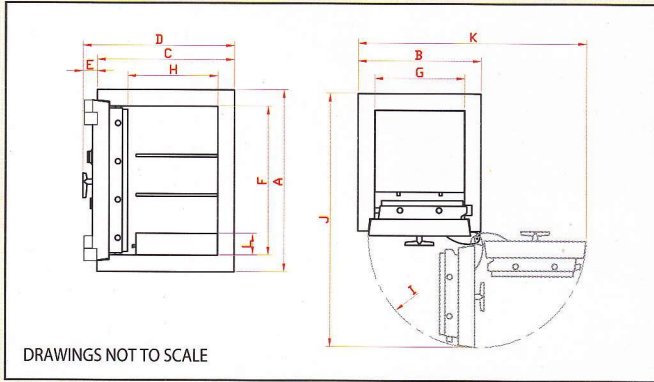

### Fire Test

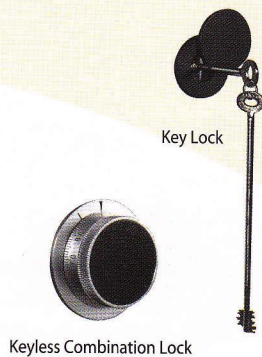
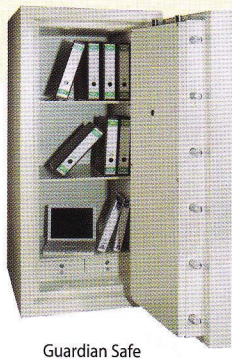
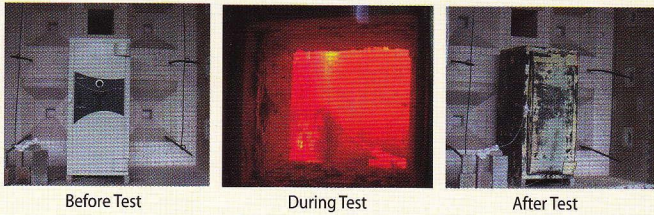

### Keyless Combination Lock

Secured by one 3-wheel Keyless Combination Lock listed under UL Group 2, VdS class 2, Cen B. Capable of 1,000,000 changes of code. The operation of this lock is simple. The code can be changed easily, and security can be maintained over the safe whenever there is a change of staff.

### Key Lock

Secured by one 11-lever double bitted Key Lock with detachable key bit certified under EN 1300-B, ECB-S, VdS class 2, CNPP a2p Niveau B, GOST class C, IMP class B.

*Authorised dealer:*

### Options

- **Night Drawer Trap (NDT)** - Allow for effective deposit of cash and documents through a secured drawer without having to open the safe's main door. Upon closing the drawer, the contents would fall into the safe. An "Anti-Fishing Plate" is also incorporated to protect against 'fishing' attempts to remove the safe's content through the Trap. Guardian Safe sizes : **1, 2 and 3** can be fitted with the NDT facility.  
**Drawer Clear Opening** : 239mm (W) x 153mm(H) x 125mm (D)  
**Night Drawer Trap External Height** : 254mm
- **Envelope Slot** - Specially designed with a slit 13mm (W) x 152mm (L) on the top face of the safe to facilitate easy and convenient deposit of small amount of cash and other less bulky documents without having to open the safe. Like the NDT, an "Anti-Fishing Plate" is installed to protect against 'fishing' attempts.
- An alarm kit may be incorporated into the safe for possible connection to the premise's main alarm system.
- A Blinder Shield and Dial Check Locks can be fitted to the combination lock as an option.
- A choice of two or three movement timelocks may also be fitted as an additional requirement. Other electronically operated locks may also be fitted as an option.

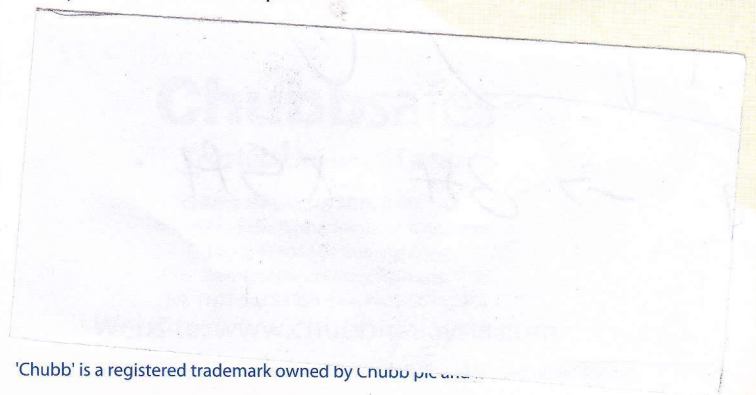

*Note: Chubb safes policy is one of constant improvement. We reserve the right to alter any specification contained in this publication without prior notification. Variance ±5mm.*

A member of the Sime Darby Group

